

Three-phase  
UPS

# DELPHYS MX

from 250 to 500 kVA

your MaXi protection up to 3 000 kVA

## High quality power supply

- High quality output voltage and frequency thanks to fast digital SVM control (Space Vector Modulation) on-line double conversion.
- Perfect sinusoidal output, even with non-linear loads, for optimum equipment performance (Crest Factor 3:1).

## High reliability and availability

- Fault tolerant architecture with built-in redundancy.
- A choice of parallel redundant configurations.
- A global solution providing redundancy in close proximity to applications: UPS and Static Transfer Systems.

## More power for latest-generation leading IT loads

The **DELPHYS MX elite** range is designed to supply latest-generation leading servers without over rating the UPS power.

12% more active power for the latest generation of servers.

The 0.9 rated output leading to lagging power factor responds perfectly to computer system high power factor load requirements. Capability to power leading and lagging loads without derating.

## Easy integration into your electrical network: **DELPHYS MX elite**

- "Clean input" rectifier absorbing sinusoidal current without filter to keep your supply network clean.
- Reduced current consumption due to high-level input power factor: 0.93 constant.
- Fully compatible with generating sets, without generator oversizing.

## Protecting your battery investment

- An innovative battery charging mode for increased battery lifetime.
- An advanced monitoring system, capable of locating and correcting problems interacting with the charger, so you can be sure your back-up will always be available.

## Cost effective equipment

- Compact with smaller footprint.
- **DELPHYS MX elite** has a built-in rectifier, considerably reducing your infrastructure costs (generator and distribution).
- Exceptional efficiency and the ENERGY SAVER function in on-line mode and keep the redundancy required.

## User-friendly operation

- Specially designed graphic touch screen for easy and ergonomic operation.
- An array of "com-slot" plug-in communication interfaces, for upgrading your operating requirements.

## Remote monitoring

- Easy remote monitoring via web browser or via customer's supervision systems (web, intranet, extranet...).
- Very open connectivity (Modbus/Jbus, Jbus tunnelling, LAN...).



Your protection for

- > Data centre
- > Industry
- > Telecommunications
- > Processes



## The voltage you require: whatever the load

**DELPHYS MX elite** ensures your power supply is of the utmost quality by using SVM (Space Vector Modulation) digital regulation:

- perfectly sinusoidal output voltage THDV < 2% with linear loads and < 3% with non-linear loads,
- output voltage precision even when load is completely unbalanced between phases,
- an immediate response to major variations in load, without deviating the output voltage ( $\pm 2\%$  in less than 5 ms),
- a very high short circuit capacity up to 4 In (Ph/N) allows selectivity.

Components and power bridges (integrating the latest high performance IGBT) enable the supply:

- non-linear loads with high crest factor up to 3,
- capability to power leading and lagging loads without derating.

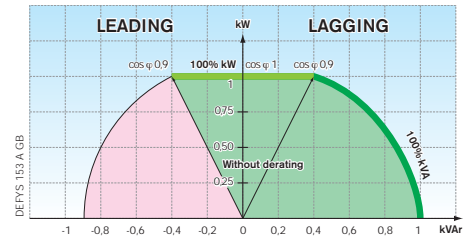

## Integration into your electrical network: a "clean" and economical rectifier

**DELPHYS MX elite**, guarantees total compatibility with your low voltage electrical power supply system and, in particular, with generating sets:

- sinusoidal current at rectifier THDI input: 4.5% without filter,
- increased power factor upstream of the rectifier: 0.93 without filter, reducing the current consumed, and therefore the size of cables and protective devices,

- gradual, sequential start-up of the rectifiers in parallel, facilitating take up by the generating set,
- delayed battery recharge when running on generating set to reduce power consumption.

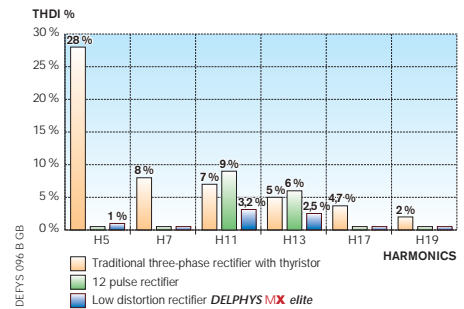

## Fault tolerant architecture

**DELPHYS MX elite** integrates internal redundancy that ensures permanent power supply even during system failure:

- redundant ventilation system,
- ring bus synchronisation,
- no single point of failure since the synchronisation bus uses a fault tolerant token ring topology that accepts an accidental opening of the synchronisation loop, without UPS malfunctioning or load losses and an alarm is given to the operator at the first fault.
- "Cascade failure" protection function eliminates fault propagation downstream of a module in parallel system when configured with central bypass
- internal or external "backfeed" protection eliminates any risk of energy feedback upstream of the UPS,
- Hardware and software watchdog ensures that the power supplied to applications is secure in case of a circuit and control software fault,
- redundancy of the power supplied to the electronics, locating ventilation faults, preventive detection of faults on a battery component on request.

## Protecting your battery investment

**EBS** (Expert Battery System) technology significantly prolongs the battery life:

- charge according to an algorithm which adapts to the environmental conditions and the condition of the battery,
- eliminates overloading effects due to permanent floating, which accelerates the corrosion of the positive plates and causes the separators to dry out,
- isolation of the DC battery bus, (independent charger function). Premature ageing, caused by residual ripple from the inverter bridge is eliminated.

## Guaranteed battery availability

- the battery and DC circuit are regularly and automatically tested and the operator is notified of their condition,
- the optional **BHC** (Battery Health Check) function tests and analyses the following parameters: current supplied by branch and voltage of each segment or each block. In the event of a problem, the function automatically takes corrective measures, if the problem continues, an alarm showing the location of the fault (branch, segment or block) allows maintenance to be easily organised.



## Parallel architectures

To fulfil the most demanding needs for power supply availability, for flexibility and for the installation to be upgradeable.

- **DELPHYS MX elite modular**, growth without limits.

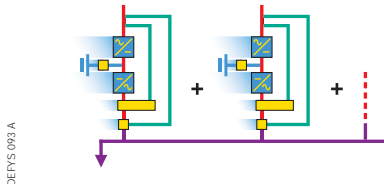

- **DELPHYS MX elite centralised bypass**, programmed growth.

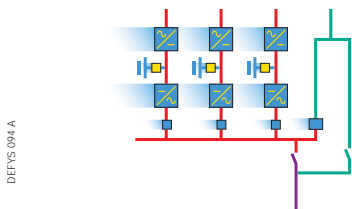

- **DELPHYS MX elite redundant bypass**, for greater availability.

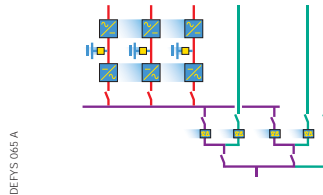

- **DELPHYS MX elite double bypass**, for easier operation.

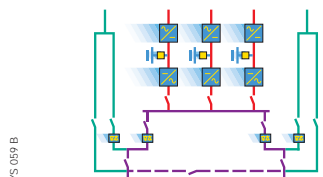

- **DELPHYS MX elite multi bypass**, to separate application types.

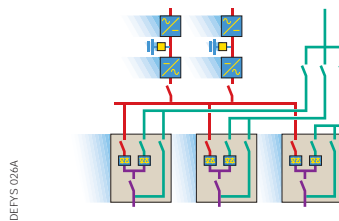

- **DELPHYS MX elite** with **Static Transfer Systems: IT SWITCH** and **LTM** to provide security as close to the applications as possible.

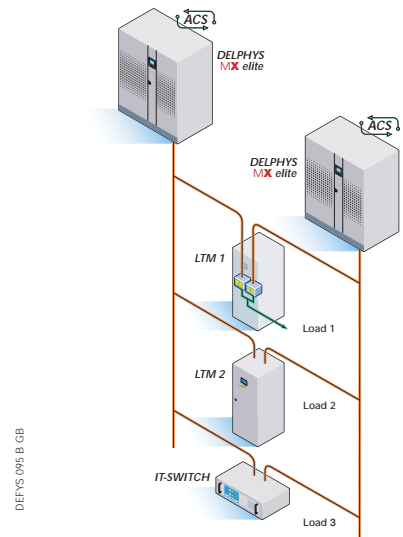

## Graphic display

Design adapted to the user: control panel with LEDs and LCD display.



## Graphic touch screen (GTS)

The operator has access to the control functions with only a few intuitive touches of the screen.

Direct access zones to sub-unit menus

Quick access to each installation module

Status bar

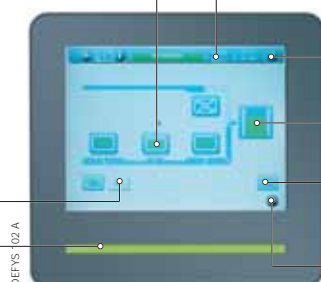

Operating mode icons

Help menu for correct operation

UPS load rate (bar graph)

Access to installation mimic panel

Preventive maintenance request

## Standard equipment

- Slots for 7 communication cards.
- Backfeed protection: detection circuit.
- Standard interface
  - 3 inputs (emergency stop, generating set, battery protection)
  - 4 outputs (general alarm, back-up, bypass, preventive maintenance needs).
- **EBS** (Expert Battery System).

## Accessories

- **BHC** battery unit monitoring.
- Graphic touch screen.
- **ACS** function for synchronisation with an external source.
- Reinforced IP protection degree.
- Ventilation filters.
- Ventilation control.

## Communication options

- Remote access panel.
- **ADC** (Advanced Dry Contacts) data input and output by dry contacts.
- RS232, RS422, RS485 serial connection JBUS/MODBUS, PROFIBUS or DEVICENET protocol.
- **MODBUS TCP** interface (JBUS/MODBUS tunneling).
- **NET VISION** interface for LAN Ethernet network.
- GSM modem for SMS alerts.

## Remote maintenance

- **TELESERVICE** for continuous monitoring via the SOCOMEC UPS maintenance service.

## UPS and batteries

A compact and integrated system.

UPS	DELPHYS MX	DELPHYS MX elite	Battery for back-up time			
			10 minutes		15 minutes	
UPS power kVA	Weight kg	Weight kg	W mm	Weight kg	W mm	Weight kg
250	1650	2210	2400	3670	2400	3770
300	1700	2260	2400	3670	3200	4600
400	1800	2450	3200	4890	4000	6110
500	-	2900	3200	5560	4800	7115

DEFYS 085 B GB

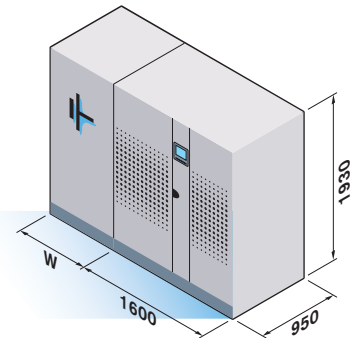

## Common cabinet

For parallel systems with central bypass.

Power <sup>(1)</sup> kVA	W mm	D mm	Weight kg
300	600	800	270
400	600	800	300
600	1000	800	420
800	1000	800	450
1200	1300	800	600
2000	2600	1200	1800

(1) For other power ranges, please consult us.

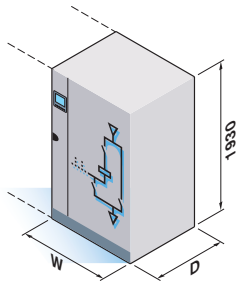

DEFYS 086 A GB

## Double conversion architecture

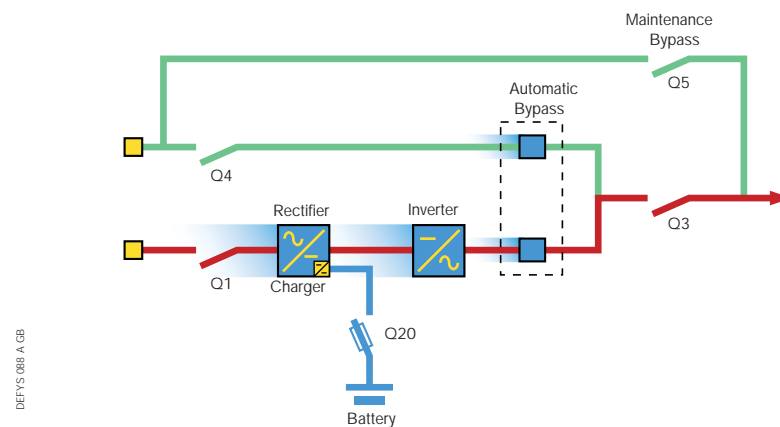

DEFYS 088 A GB

## Technical data

Sn [kVA]	250	300	400	500
Pn [kW] (elite version, output PF: 0.9)	225	270	360	450
Pn [kW] (base version, output PF: 0.8)	200	240	320	-

RECTIFIER INPUT	
Voltage	three-phase 380 V - 400 V - 415 V <sup>(1)</sup>
Acceptable tolerance	340 to 460 V
Frequency	50 - 60 Hz (45 to 65 Hz)
Power factor	0.93 constant
DELPHYS MX elite current distortion rate	THDI: 4.5% without filter
OUTPUT	
Voltage (configurable)	three-phase + N 380 V - 400 V - 415 V <sup>(1)</sup>
Tolerance	
In static load conditions	< 1%
In dynamic load conditions from 0 to 100%	± 2% in 5 ms
Voltage distortion rate with non-linear loads according to EN/IEC 62040-3	Ph/N: < 3% Ph/Ph: < 2.5%
Acceptable crest factor without de-rating	3:1
PF acceptable without de-rating	lag. to 0.9 lead.
Frequency (configurable)	50 - 60 Hz
Autonomous frequency tolerance	± 0.2%
Overload	1 min: 150% 10 min: 125%
Efficiency	
Global <sup>(2)</sup>	94%
In ECO-MODE configuration	98%
ENVIRONMENT	
Noise level (ISO 3746) <sup>(2)</sup>	72 dBA
Compliance to standards	
Safety	IEC 62040-1-2 / IEC 60950
EMC	IEC 62040-2 IEC 62040-3
Technical data	
Classification according to IEC 62040-3	Voltage Frequency Independent, on-line double conversion VFI - SS - 111

(1) Three-phase 220-230-240 V on demand. - (2) As per power range.

## Bypass transformer

For galvanic isolation.

Power <sup>(1)</sup> kVA	W mm	Weight kg
300	1000	800
400	1200	1000
500	1200	1500
600	1200	1800
800	1200	2000
1000	1200	2500
1200	1600	2700

(1) For other power ranges, please consult us.

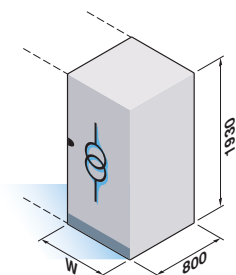

DEFYS 087 A GB